

! INFO !

Do not charge the battery of the towing vehicle and/or towed vehicle directly via the socket.

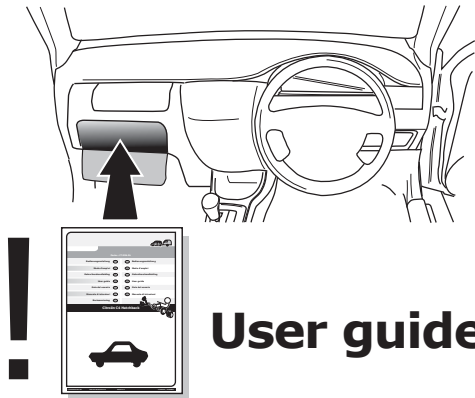

User guide

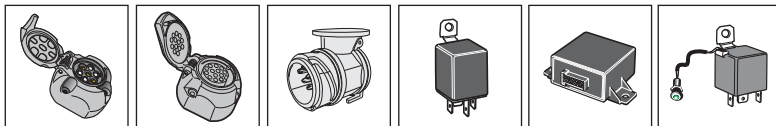

SPARE PARTS

www.ecs-electronicsuk.co.uk



Partnr.: OP-056-BLU

User Guide

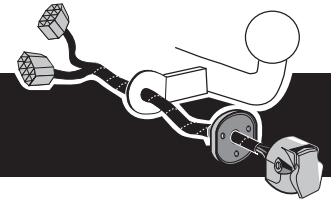

Opel Movano van	06/2004 >> 12/2021
Renault Master van	06/2004 >>
Nissan NV400 van	03/2010 >> 12/2021
Nissan Interstar van	01/2022 >>



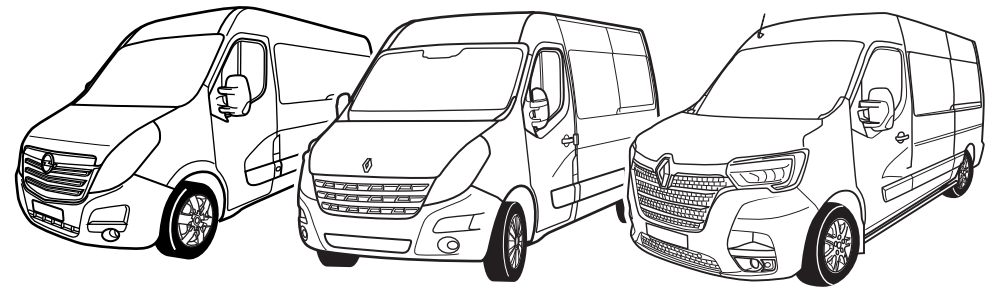

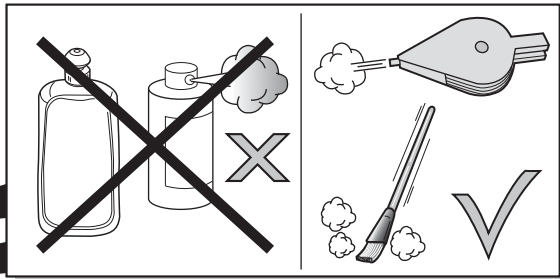
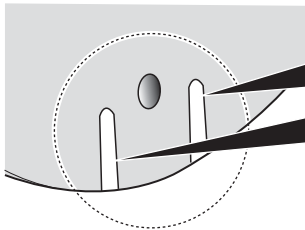
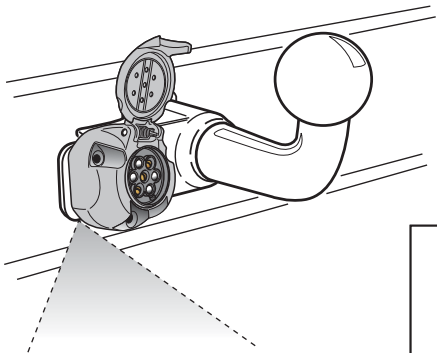
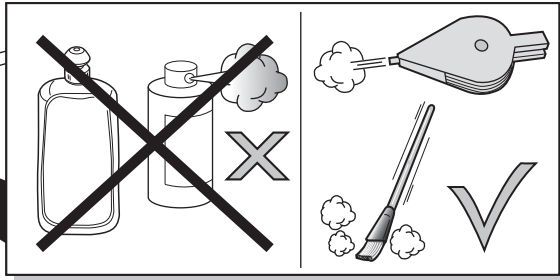
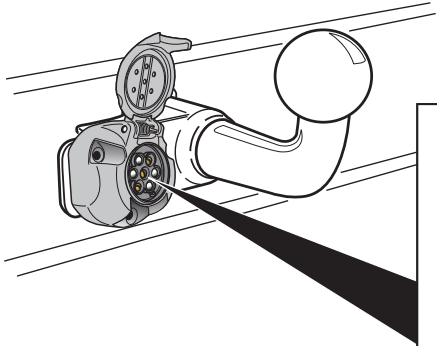
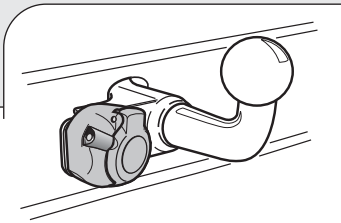

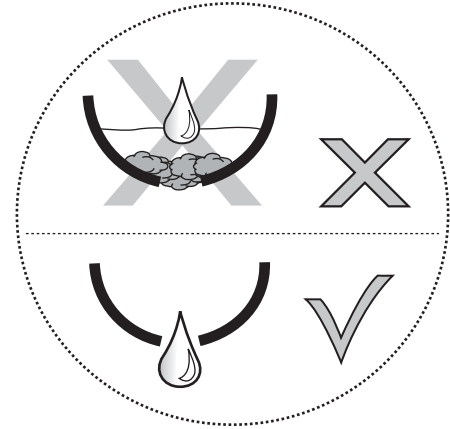
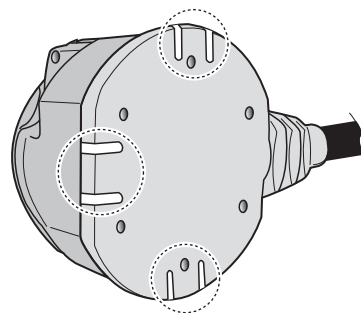
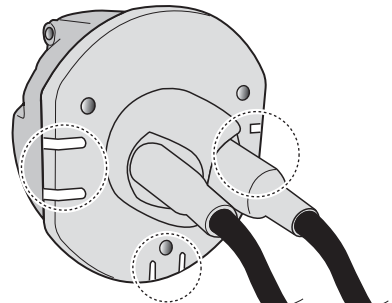
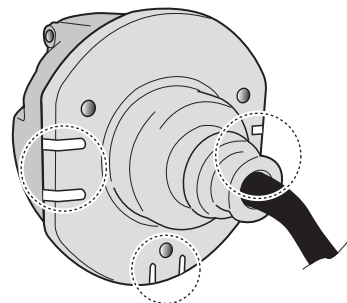
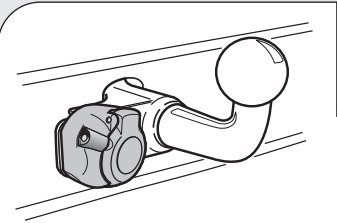
Vehicles with trailer-preparation only!







SOCKET CONNECTION

DIN/ISO 1724							
	1/L	2	3/31	4/R	5/58-R	6/54	7/58-L
Pmax	21W	2x21W		21W	52W	3x21W	52W
Colour	Yellow	Blue	White	Green	Brown	Red	Black